

∅172 K series

x150x38mm



General Specifications

- Motor : Singal phase induction capacitor motor
- Frame & Impller : Metal
- Storage temperature : -40°C to +75°C
- Operating temperature : -10°C to +70°C

Major Characteristic Parameters

Model	Bearing System	Rated Voltage	Freq.	Power Input	Rated Speed	Maximum Air Flow	Maximum Static Pressure	Sound Level	Weight		
Part NO.	B / S	V	Hz	W	RPM	m ³ /min	CFM	mm-H ₂ O	In-H ₂ O	dBA	Kg
K0051B11	B / S	110	50/60	35/32	2850/3200	5.21/6.17	184/218	15.7/15.7	0.62/0.86	49/52	0.85
K0051B21	B / S	230	50/60	35/32	2850/3200	5.21/6.17	184/218	15.7/20.0	0.62/0.86	49/52	0.85

*Bearing system B: Two Ball Bearing F: Fluid Bearing S: Sleeve Bearing

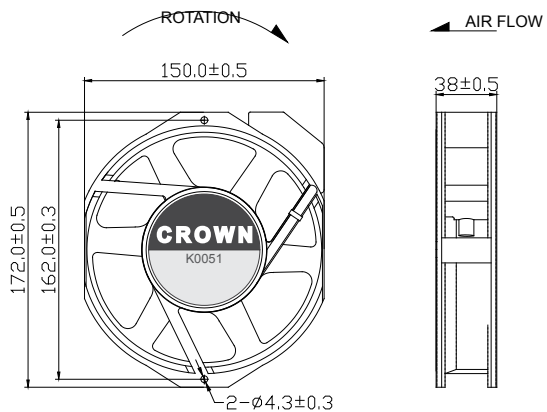
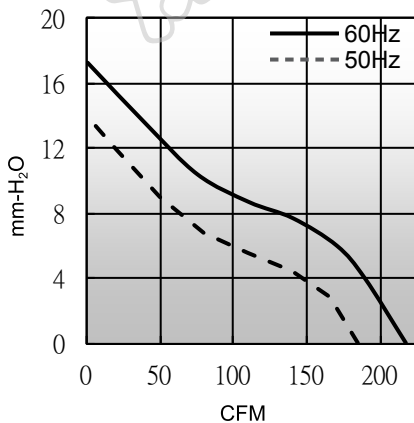

unit:mm